

Silen Hybrid 2

An inclusive habitat for all Sharp minds move in various ways. Some walk, some use wheelchairs. This pod is designed to accommodate everyone.





 1-4 people





- 

Accessible
Improved comfort and wheelchair access with an extra-low threshold and a wide automatic door.
- 

Ultimate two-way privacy
Market-leading sound reduction for wheelchair-accessible office pods.
- 

Comfortable
Ergonomic, quiet, echo-free, and speech-optimized. Automated LEDs and ventilation. Over twice the standard airflow rate.
- 

Easy to relocate
Add-on mobility kit for in-office relocation. Easy reassembly for moving offices.
- 

Spacious
Suitable for 4 wheelchair users; otherwise, seats up to 8. Offers ample space to stretch and move around. Available with furniture of your choice.
- 

Endless customization
Swap side skins and cover trims with a snap of a magnet. Enjoy a variety of colors, fabrics, and furnishing options.
- 

Modularity
The modular design enables changing the pod size whenever needed. Add modules to create bigger spaces or split larger pods into smaller spaces.
- 

Sustainable
Fully renewable with a 20+ year lifespan. Designed sustainably across materials, production, and impact on surrounding environments.

Interior colour

Standard colours



Exterior colour

Standard colours*



Additional colours for extra fee



Textile sides Camira Quest



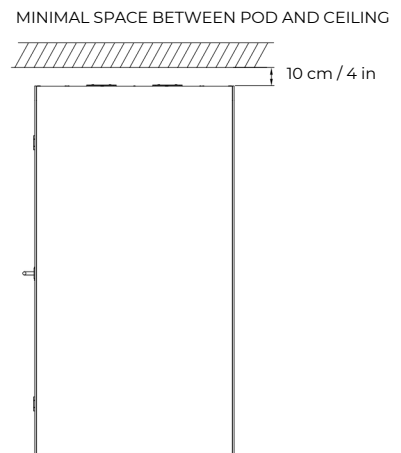
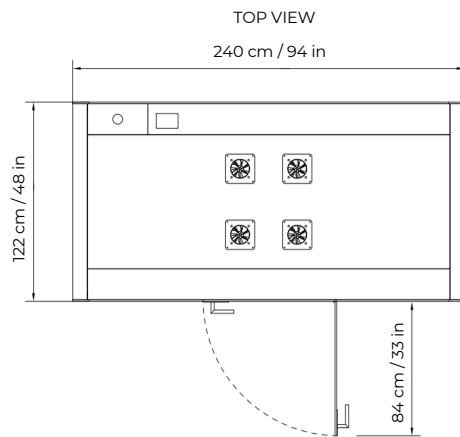
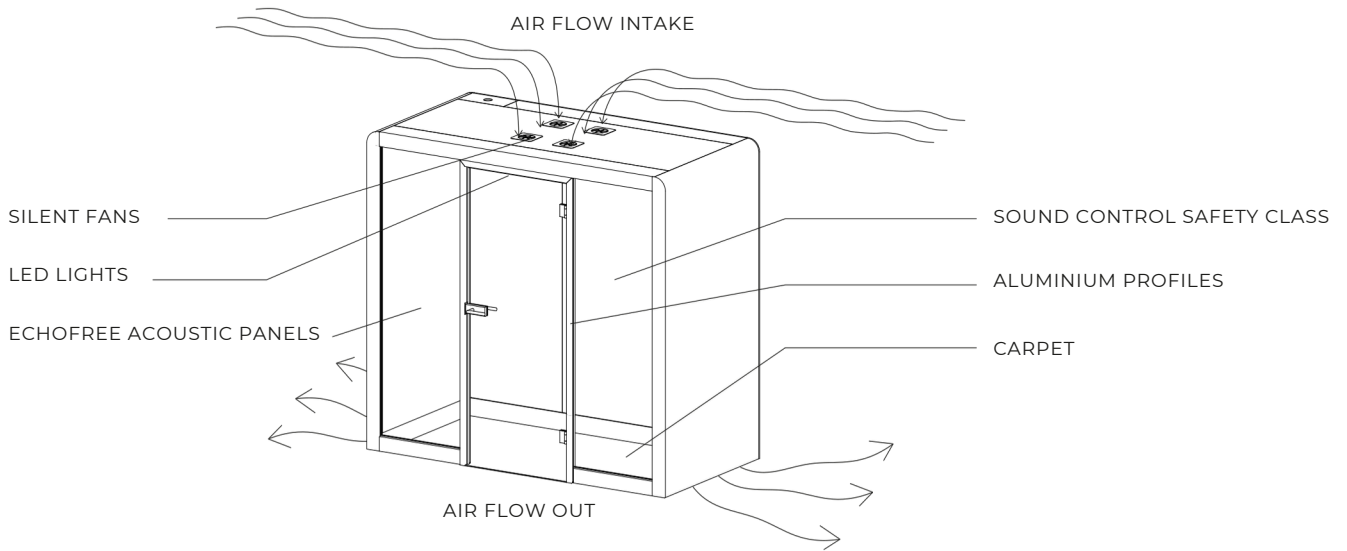
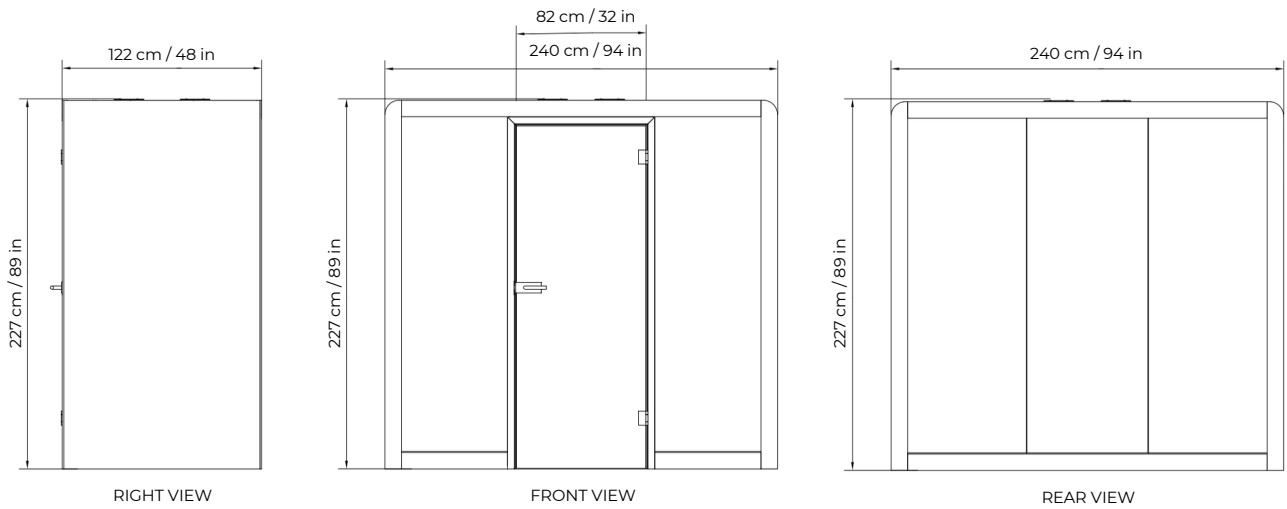

Space 2 Hybrid technical specification

GENERAL PRODUCT INFO

Exterior size (W×D×H)	240 × 122 × 227 cm / 94 × 48 × 89 in
Interior size (W×D×H)	220 × 110 × 216 cm / 87 × 43 × 85 in
Weight (net)	650 kg / 1433 lb
Weight with crate	780 kg / 1719 lb
Exterior	Laminated exterior panels and cover trims. Medical grade antibacterial laminate
Glass	Sound Control laminated safety glass. Sound insulation STC 40 dB
Walls/structure	EchoFree panel - sandwich element and structure of FSC birch plywood, ecological foam and acoustic felt. Sound insulation STC 49 dB. Acoustic absorption class A
Roof	EchoFree panel - sandwich element of birch plywood and acoustic felt. Sound insulation STC 49 dB. Acoustic absorption class A
Floor	Sandwich element of birch plywood, acoustic wool. Acoustic absorption Class B
Carpet	Antistatic and stain resistant low loop pile carpet for public spaces, EN 1307. Flammability B _{fl-s1}
Door handedness	Right- or left-handed door. Door handedness can be chosen
Furniture	Optional. Different sets are available
Air ventilation	Low energy-consumption automatic air circulation system (stand by 3,4W; in operation 6,8W). Air circulation speed is at least 85 l/s
Electrical connections	Option one: add foldable table for sockets Option two: 2 x 110-240 V + USB-A+C in wall
Power cord	5m long cord with plug type depending on the region. Connection either from the top or bottom of the pod, can be chosen during installation.
Lighting	3000K or 4000K automatic LED lightning (28 W, 3000 lm). Low consumption, energy-efficient

CERTIFICATION

Product safety	UL962 Listed
Electrical safety	CE-mark / UL962
Fire safety	Listed Class A according to UL 723, ASTM E84, ASTM E162 (walls and ceiling)
Emissions	Indoor Advantage™ Gold certified by SCS Global Services



Space 2 Hybrid extra features



Self-closing door hinges



Additional power outlet Pluto under the table



Additional power outlet Desk2 on the table



Additional power outlet Slim on the table (US)



Retractable coat/bag hook



Control panel



Occupancy light



Screen bracket on back glass

EXTRA FEATURE

Self-closing door hinges

Additional power outlet Pluto under the table

Additional power outlet Desk2 on the table On table top. 2 X 230 V, 1 X USB-A, 1 X USB-C

Additional power outlet Slim on the table (us) US only. 3 x 120V, 2 x USB-A

Power outlet under sofa (1 x 230V / USB A/C) Additional information.

LAN/RJ45/HDMI connections

Control panel Airflow dimmer, light brightness dimmer, light temperature selection and controls for optional extras (face light, smart glass etc.)

Occupancy light

Screen bracket on back glass

Screen bracket on side wall

Frosted film on glass

Retractable coat/bag hook

Sprinkler prep Knockout with a tube inside. The ceiling module for housing a sprinkler. Does not include a sprinkler. Sprinkler needs to be installed by a certified company.

Seismic kit Brackets to mount the floor module to the existing floor with anchor bolts

Mobility kit Set of detachable casters for moving booths. Can be used for all Space Hybrid models.



Options for surfaces

Standard colours

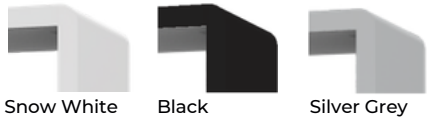

Snow White Black Silver Grey

Veneer



Oak Veneer Dark Oak Veneer

Extra colours

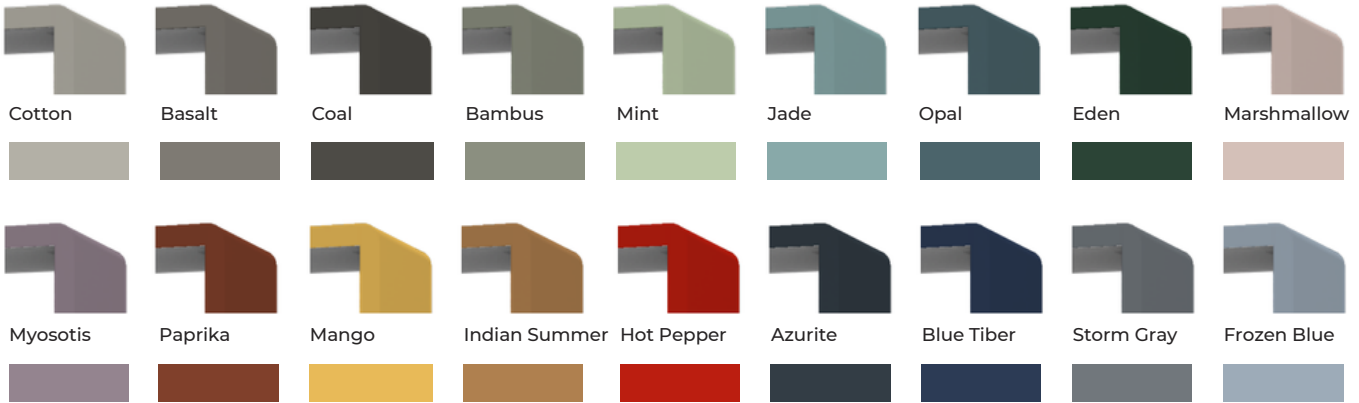

Standard wall and ceiling



Light gray Dark gray Black Sand

Standard floor

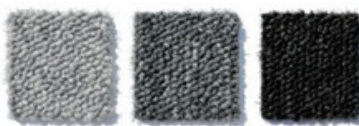

Light gray Dark gray Black

Standard profiles



White Anodized gray Black

Textile sides (Camira Quest)*



* Only for Silén Dynamics Generation

Fully upcycled Furniture textiles with 70% marine plastic content

