



# Silen Space Max

Big teams, deep missions  
From focused planning and brainstorming sessions to a war room where team leads can tackle a crisis, it's big in here. In another life, this pod could be a loft.



 1-8 people





 **Ultimate two-way privacy**  
Market-leading in performance. Blocks 41 dB outside noise, 31 dB (Class A) inside speech. Office-tested, ISO-approved in the laboratory.

 **Comfortable**  
Ergonomic, quiet, echo-free, and speech-optimized. Automated LEDs and ventilation. Over twice the standard airflow rate.

 **Movable**  
Hidden wheels allow effortless relocation in the office. Prefabricated design offers easy disassembly and reassembly when moving.

 **Spacious**  
Ample space to sit, stretch, stand, and move around. Available with furniture of your choice.

 **Endless customization**  
Swap side skins and cover trims with a snap of a magnet. Choose from a variety of colors, fabrics, and furnishing options.

 **Modularity**  
The modular design enables changing the pod size whenever needed. Add modules to create bigger spaces or split larger pods into smaller spaces.

 **Sustainable**  
Fully renewable with a 20+ year lifespan. Designed sustainably across materials, production, and impact on surrounding environments.

 **Interior colour**  
Standard colours



 **Exterior colour**  
Standard colours\*



**Additional colours for extra fee**



**Textile sides Camira Quest**



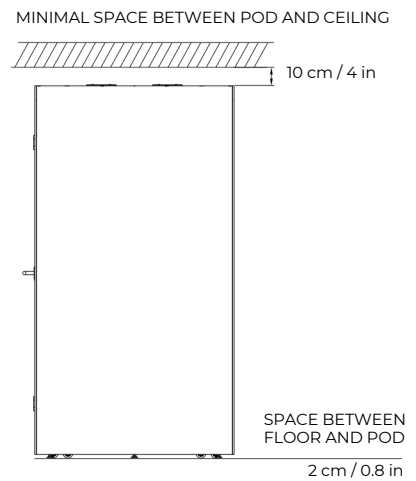
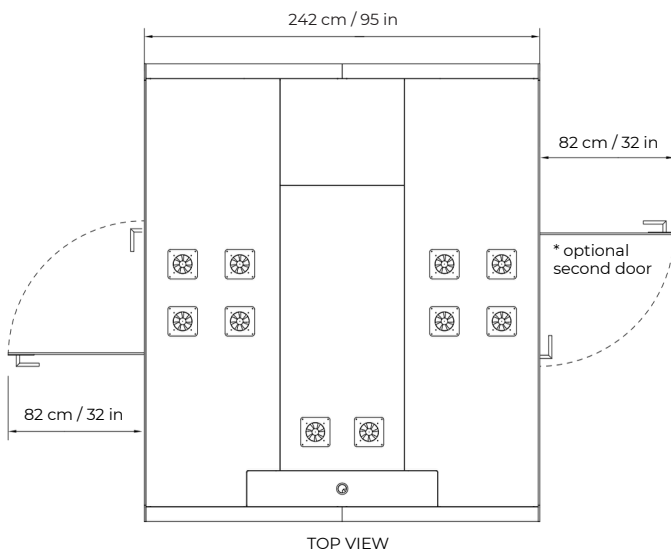
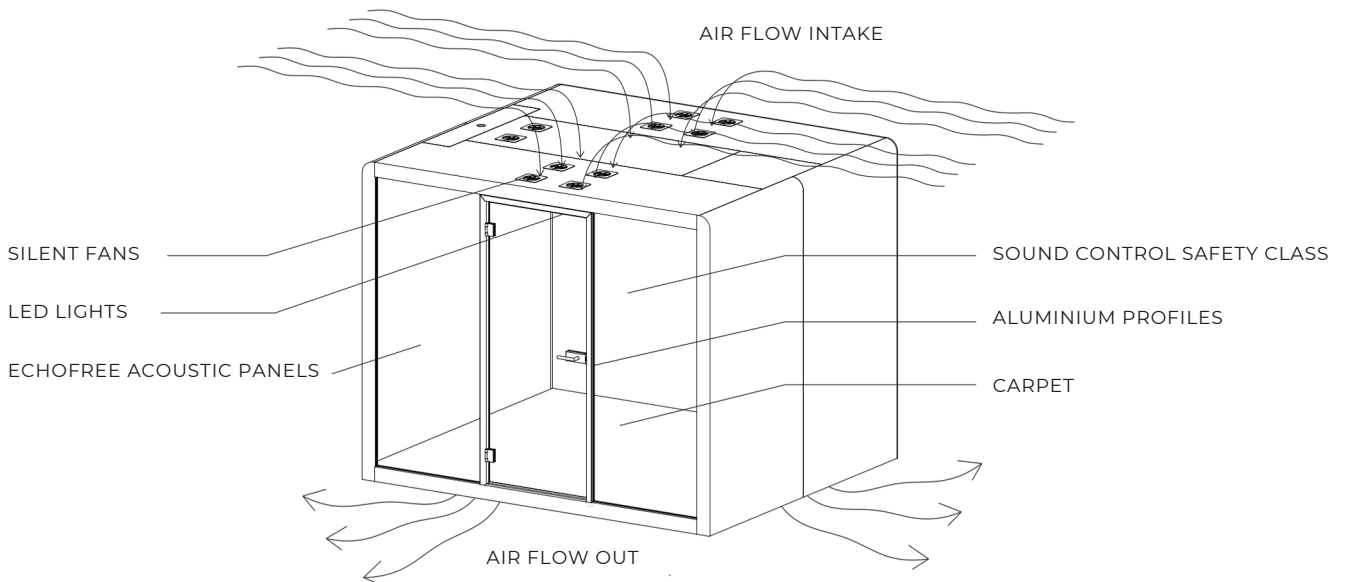
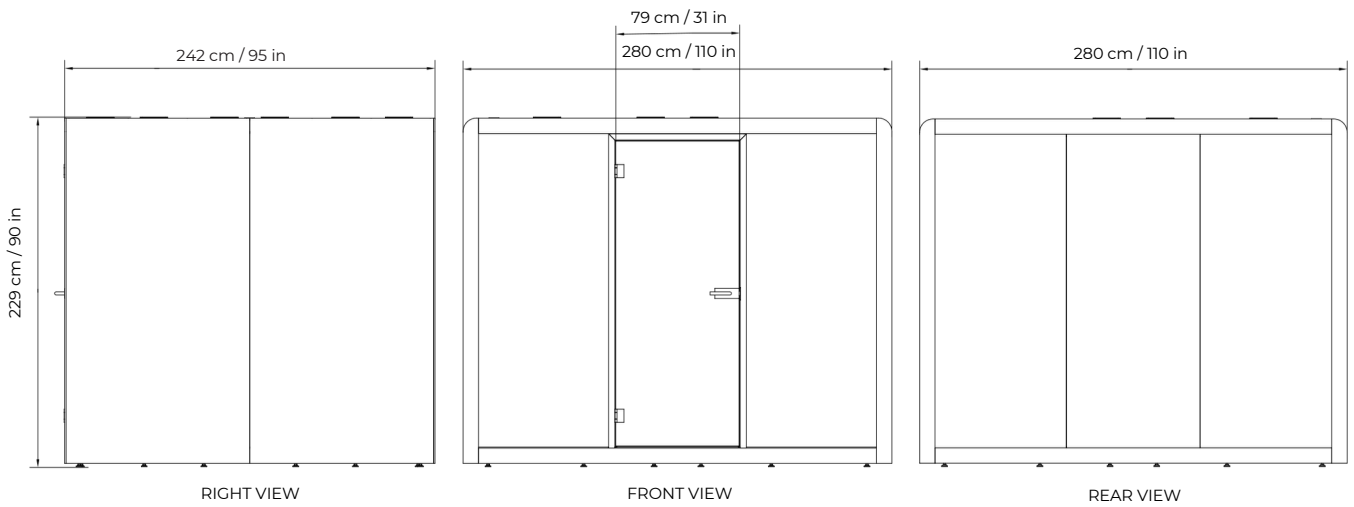

# Space Max technical specification

## GENERAL PRODUCT INFO

Exterior size (W×D×H)	280 × 242 × 229 cm / 110 × 95 × 90 in
Interior size (W×D×H)	260 × 236 × 205 cm / 102 × 93 × 81 in
Weight (net)	1500 kg / 3307 lb
Weight with crate	1760 kg / 3880 lb
Exterior	<p><b>Side panels:</b> Metal sheet with sand-structured powder coating. Fixed with magnets and easily exchangeable.</p> <p><b>Front and back trims:</b> Covered with medical-grade antibacterial laminate. Fixed with magnets and easily exchangeable.</p>
Glass	Sound Control laminated safety glass. Sound insulation STC 40 dB
Walls/structure	EchoFree panel - sandwich element and structure of FSC™ birch plywood, ecological foam and acoustic felt. Sound insulation STC 49 dB. Acoustic absorption class A
Roof	EchoFree panel - sandwich element of birch plywood and acoustic felt. Sound insulation STC 45 dB. Acoustic absorption class A
Floor	Sandwich element of birch plywood, acoustic wool. Acoustic absorption Class B
Carpet	Antistatic and stain resistant low loop pile carpet for public spaces, EN 1307. Flammability B <sub>f1-s1</sub>
Door handedness	Right- or left-handed door. Door handedness must be chosen. Option for having two doors on front and back.
Furniture	Optional. Different sets are available
Air ventilation	Low energy-consumption automatic air circulation system (stand by 6,8W; in operation 17W). Air circulation speed is at least 155 l/s
Electrical connections	Option one: 3 x 110-240 V (10 A) Option two: 2x 110-240 V (10 A) + USB-A+C Other power and data options available upon request
Power cord	5m long cord with plug type depending on the region. Connection either from the top or bottom of the pod, can be chosen during installation.
Lighting	3000K or 4000K automatic LED lightning (28 W, 3000 lm). Low consumption, energy-efficient
Casters	For moving during installation and easy relocation. Hidden. Can be activated any time.
Adjustable legs	For levelling. Levelling from inside the booth

## CERTIFICATION

Product safety	UL962 Listed
Electrical safety	CE-mark / UL962 Listed
Fire safety	Class A according to UL 723, ASTM E84, ASTM E162 (walls and ceiling)
Emissions	Indoor Advantage™ Gold certified by SCS Global Services
Speech level reduction	31,1 dB / Class A according to ISO 23351-1, measured in accredited lab
Airborne sound insulation R'w	41 dB according to ISO 16283-1 and ISO 717-1, measured on site by an accredited specialist
Sound transmission class STC	41 dB according to ASTM E90, measured on site by an accredited specialist



## Space Max extra features



Self-closing door hinges



Additional power outlet Pluto under the table



Additional power outlet Desk2 on the table



Additional power outlet Slim on the table (US)



Retractable coat/bag hook



Air flow and lighting dimmer



Occupancy light



Screen bracket on back glass



Sprinkler prep

### EXTRA FEATURE

Self-closing door hinges

Additional power outlet Pluto under the table

Additional power outlet Desk2 on the table On table top. 2 X 230 V, 1 X USB-A, 1 X USB-C

Additional power outlet Slim on the table (us) US only. 3 x 120V, 2 x USB-A

Power outlet under sofa (1 x 230V / USB A/C) Additional information.

LAN/RJ45/HDMI connections

Control panel Airflow dimmer, light brightness dimmer, light temperature selection and controls for optional extras (face light, smart glass etc.)

Occupancy light

Screen bracket on back glass

Screen bracket on side wall

Frosted film on glass

Retractable coat/bag hook

Sprinkler prep Knockout with a tube inside. The ceiling module for housing a sprinkler. Does not include a sprinkler. Sprinkler needs to be installed by a certified company.

Seismic kit

Brackets to mount the floor module to the existing floor with anchor bolts

Extra door



# Options for surfaces

## Standard colours

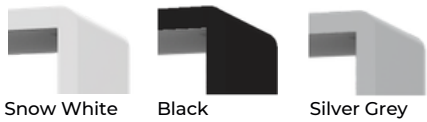

Snow White    Black    Silver Grey

## Veneer



Oak Veneer    Dark Oak Veneer

## Extra colours

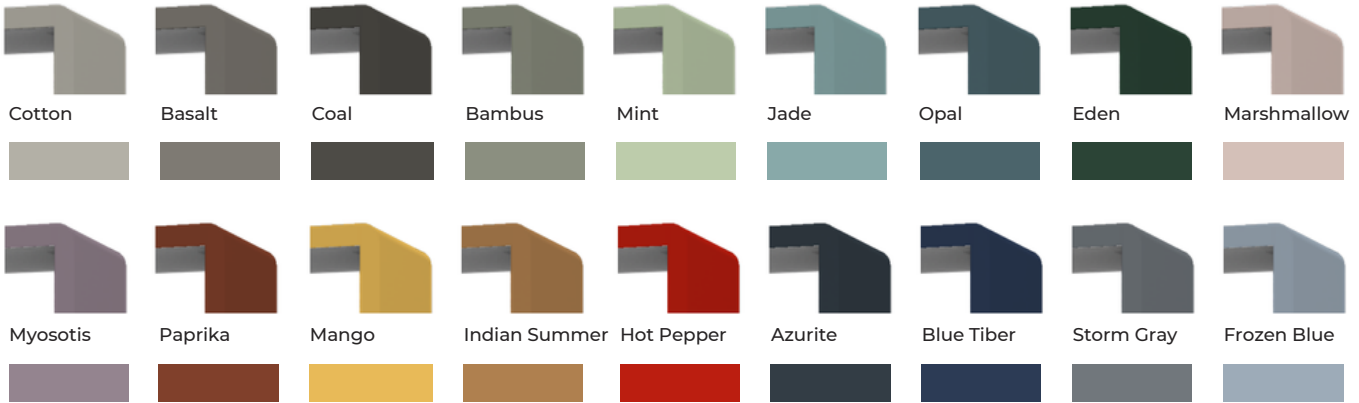

## Standard wall and ceiling



Light gray    Dark gray    Black    Sand

## Standard floor

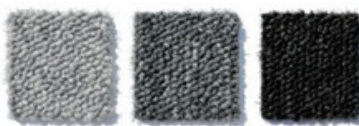

Light gray    Dark gray    Black

## Standard profiles



White    Anodized gray    Black

## Textile sides (Camira Quest)\*



\* Only for Silen Dynamics Generation

Fully upcycled Furniture textiles with 70% marine plastic content

